

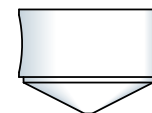

pistons

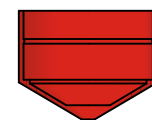

syringe barrels

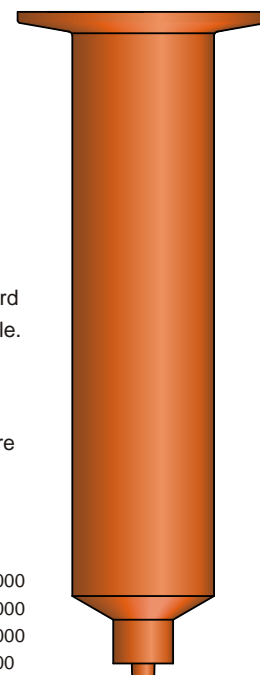

tips



700 Series Dispensing Components

Our 700 Series Premier Dispensing components are silicone and chloride free and designed to work with industry standard equipment. 700 Series dispensing components ensure accuracy, repeatability and productivity. Bulk packages are available.

700 Series Syringe Barrels

Unique ultra-low draft construction of inner diameter yield high accuracy and stability. They are comprised of industry compliant silicone and chloride free, low friction Polypropylene. Available in three different colors: Natural for most generic applications, Amber provides protection of UV/visible light block (up to 520nm), but with the ability to see material inside the barrel; and Black for total light block. Sold in bulk packages.

SIZE	NATURAL	AMBER	BLACK
3 cc	7030LL1N-1000	7030LL1D-1000	7030LL1B-1000
5 cc	7050LL1N-1000	7050LL1D-1000	7050LL1B-1000
10 cc	7100LL1N-1000	7100LL1D-1000	7100LL1B-1000
30 cc	7300LL1N-500	7300LL1D-500	7300LL1B-500
55 cc	7550LL1N-250	7550LL1D-250	7550LL1B-250

700 Series Air Powered Pistons

Spread the pressure evenly across product, using a piston, for consistent dispensing of even high viscosity products. Wiper Pistons (white) provide a seal for low to medium viscosity fluids. Straight Wall Pistons (red) are recommended for reduced stringing with medium to high viscosity products. Sold in bulk package of 1000. Made from Polyethylene.

SIZE	Wiper Piston (White)	Straight Wall (Red)
3 cc	7030009W-1000	7030006R-1000
5 cc	7050009W-1000	7050006R-1000
10 cc	7100009W-1000	7100006R-1000
30 - 55 cc	7300009W-1000	7300006R-1000

700 Series Syringe Barrel Kits

For your convenience these syringe barrels and pistons are packaged together without pistons inserted. Sold in bulk package (syringe barrel and corresponding Wiper Piston).

SIZE	NATURAL	AMBER	BLACK
3 cc	7030LL1NW-1000	7030LL1DW-1000	7030LL1BW-1000
5 cc	7050LL1NW-1000	7050LL1DW-1000	7050LL1BW-1000
10 cc	7100LL1NW-1000	7100LL1DW-1000	7100LL1BW-1000
30 cc	7300LL1NW-500	7300LL1DW-500	7300LL1BW-500
55 cc	7550LL1NW-250	7550LL1DW-250	7550LL1BW-250

700 Series Syringe Barrel Dimensions

CAPACITY	Overall Length A inches/mm	Outside Diameter B inches/mm
3 cc	2.96/75.18	0.46/11.56
5 cc	2.83/71.9	0.59/14.99
10 cc	3.58/90.9	0.72/18.29
30 cc	4.66/118.36	0.99/25.15
55 cc	6.91/175.51	1.01/25.65

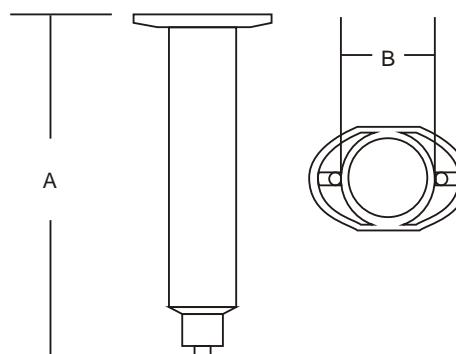

KRAYDEN, INC.

AUTHORIZED DISTRIBUTOR
[HTTP://KRAYDEN.COM](http://KRAYDEN.COM) 1-800-448-0406



700 Series Tip Cap

Designed to seal the syringe barrel tip during storage and shipment. Fits all syringe barrel sizes. Sold in bulk package of 1000. Made from Polypropylene.

Part No.	Description
7015LL-1000	700 Tip Cap Double Helix Thread Orange
TE7015LB-1000	700 Tip Cap Double Helix Thread Black



700 Series End Caps

Designed to seal large end of the syringe barrel to ensure no contaminants come in contact with material during storage and shipment. Sold in bulk package of 1000. Made from Polyethylene.

SIZE	END CAP
3 cc	703000CR-1000
5 cc	705000CR-1000
10 cc	710000CR-1000
30/55 cc	730000CR-1000



700 Series Receiver Head Assembly

Receiver Head Assemblies are the connecting link between time/pressure controllers and Syringe Assemblies. These assemblies provide a safe connection for accident proof dispensing. Available with 3 or 6 feet of tubing. Consists of receiver head with O-ring, tubing and male quick connector. Sold individually. Made of Delrin®.

SIZE	3' HOSE	6' HOSE	NO HOSE
3 cc	70303RHB	70306RHB	70300RHR
5 cc	70503RHB	70506RHB	70500RHR
10 cc	71003RHB	71006RHB	71000RHR
30/55 cc	73003RHB	73006RHB	73000RHR

Replacement O-rings for Receiver Head

Sold in packs of 10.

Receiver Head

Size	EPR O-ring	Viton O-ring
3 cc	P3015EPK	P3019VPK
5 cc	P3016EPK	P3020VPK
10 cc	P3017EPK	P3021VPK
30/55 cc	P3018EPK	P3022VPK



TS700 Series Manual Syringe Gun

Lightweight syringe barrel applicator gun provides excellent control for medium/high viscosity products. Easy to use. No dripping or mess.

SIZE	MANUAL SYRINGE GUN
5cc	TS705SG
10cc	TS710SG
30cc	TS730SG
55cc	TS755SG

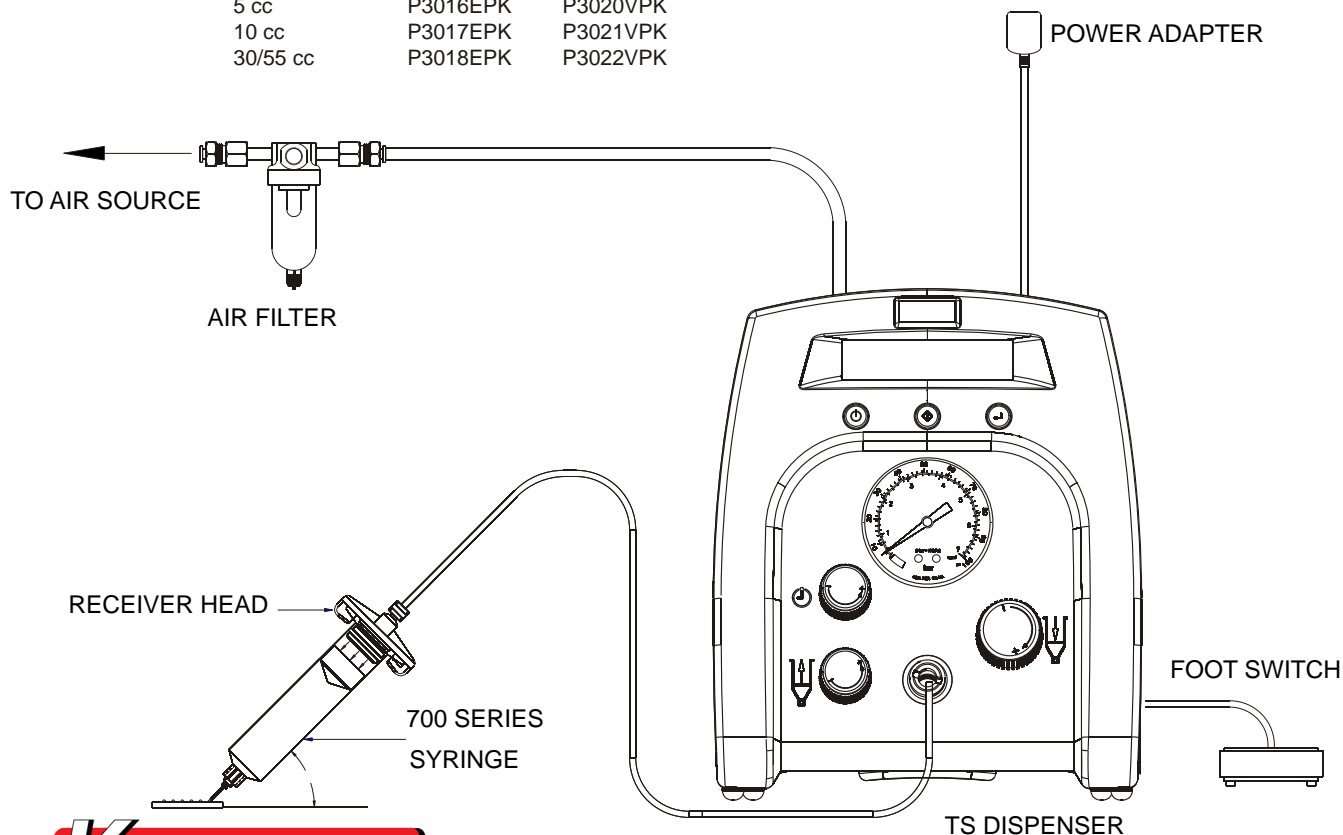

AUTHORIZED DISTRIBUTOR
[HTTP://KRAYDEN.COM](http://KRAYDEN.COM) 1-800-448-0406

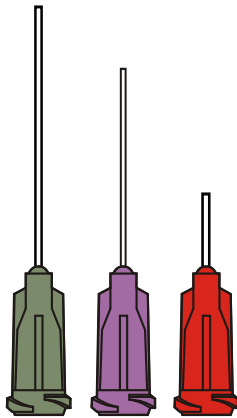

TE Dispensing Tips

The TE series consist of a stainless-steel cannula with a double helix Polypropylene hub.

This premium line of dispensing tips is burr-free, and has an electro-polished cannula for unobstructed and consistent material flow. In addition, they are silicone and chloride free. Sold in bulk pack of 1000.

Gauge	1/4" (6.35mm)	1/2" (12.7mm)	1" (25.4mm)	1-1/2" (38.1mm)
14		TE714050-1000	TE714100-1000	TE714150-1000
15		TE715050-1000	TE715100-1000	TE715150-1000
18	TE718025-1000	TE718050-1000	TE718100-1000	TE718150-1000
20	TE720025-1000	TE720050-1000	TE720100-1000	TE720150-1000
21	TE721025-1000	TE721050-1000	TE721100-1000	TE721150-1000
22	TE722025-1000	TE722050-1000	TE722100-1000	TE722150-1000
23	TE723025-1000	TE723050-1000	TE723100-1000	TE723150-1000
25	TE725025-1000	TE725050-1000		
27	TE727025-1000	TE727050-1000		
30	TE730025-1000	TE730050-1000		
32	TE732025-1000			

TE Bent Dispensing Tips

These TE bent tips are precision bent at 45° and 90° angles. Perfect for dispensing fluid in hard to reach places. Sold in packs of 50.

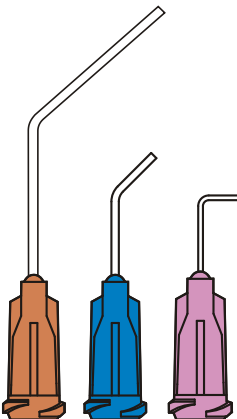

Gauge	1/2" (12.7mm)		1-1/2" (38.1mm)
	90°	45°	
14	TE714050B90PK	TE714050B45PK	TE714150B45PK
15	TE715050B90PK	TE715050B45PK	
18	TE718050B90PK	TE718050B45PK	TE718150B45PK
20	TE720050B90PK	TE720050B45PK	
21	TE721050B90PK	TE721050B45PK	TE721150B45PK
22	TE722050B90PK	TE722050B45PK	
23	TE723050B90PK	TE723050B45PK	
25	TE725050B90PK	TE725050B45PK	
27	TE727050B90PK	TE727050B45PK	
30	TE730050B90PK	TE730050B45PK	

Color Coding and Gauge

For TE Series and TE Bent Dispensing Tips

Color	Gauge	I.D. (inches)	I.D. (mm)
Olive	14	0.063	1.600
Amber	15	0.054	1.371
Green	18	0.033	0.838
Pink	20	0.024	0.610
Purple	21	0.020	0.508
Blue	22	0.016	0.406
Orange	23	0.013	0.330
Red	25	0.010	0.254
Clear	27	0.008	0.203
Lavender	30	0.006	0.152
Yellow	32	0.004	0.102



AUTHORIZED DISTRIBUTOR
[HTTP://KRAYDEN.COM](http://KRAYDEN.COM) 1-800-448-0406

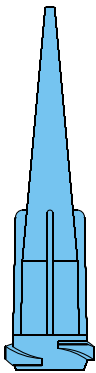

TT Dispensing Tips

These tips are molded in high density Polyethylene with UV light block additive and include a double helix Luer lock hub. The tapered tip prevents blockage and increases the flow of high viscosity materials. Sold in bulk package of 1000.

Gauge	Color	TT Needle
14	Olive	TT14-DHUV-1000
16	Grey	TT16-DHUV-1000
18	Green	TT18-DHUV-1000
20	Pink	TT20-DHUV-1000
22	Blue	TT22-DHUV-1000
25	Red	TT25-DHUV-1000
27	Clear	TT27-DHUV-1000



BT Series

Use these Double Helix Brush Tips for "spread" applications such as glues and other materials. Soft brush is made of Red Sable. Stiff brush is made of Nylon. Available in package of 12.

Gauge	Soft Bristle	Stiff Bristle
16	BT16-SOFTPK	BT16-STIFFPK
18	BT18-SOFTPK	BT18-STIFFPK
22	BT22-SOFTPK	BT22-STIFFPK

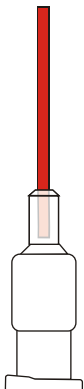

TS-P Plastic Dispensing Tips

Flexible tips allow access to hard to reach areas and allow you to "customize" the length. Ideal for CA applications. 1 1/2" length. Sold in bulk package of 500. Made from Polypropylene.

Gauge	Color	TS-P Needle
15	Grey	TS15P-1-1/2-500
16	Brown	TS16P-1-1/2-500
18	Pink	TS18P-1-1/2-500
20	Yellow	TS20P-1-1/2-500
22	Black	TS22P-1-1/2-500
25	Red	TS25P-1-1/2-500



Dispensing Tip Kit

Decide for yourself which tip to use. This kit contains a variety of the most popular 700 Series tips to let you test different tips to find the ones that fit your needs.

Part No.
TN00DKIT

Description:
Dispensing Tip Kit



AUTHORIZED DISTRIBUTOR
HTTP://KRAYDEN.COM 1-800-448-0406

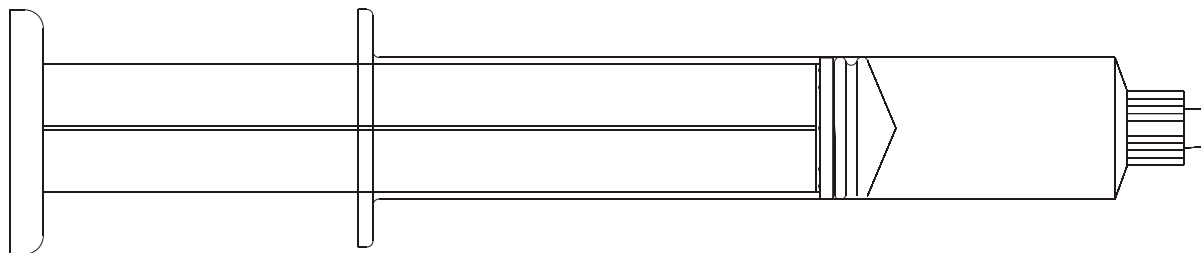

400 Series Disposable Dispensing Components

The 400 Series disposable syringes and components are available in variety of styles to meet wide range of applications. Sold in bulk packages only.

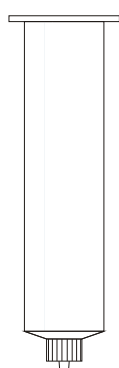

Syringe Barrels

Barrels are molded from Polypropylene. Standard style is Luer lock. Luer slip and taper tip styles are also available, however minimum quantity, lead time and pricing considerations apply. In Natural color only (for Black and Amber refer to page 4).

Part No. Description

F401L-1	400 Syringe Barrel 1cc Luer Slip
403LL-1	400 Syringe Barrel 3cc Luer Lock
406LL-1	400 Syringe Barrel 6cc Luer Lock
410LL-1	400 Syringe Barrel 10cc Luer Lock
435LL-1	400 Syringe Barrel 35cc Luer Lock
460LL-1	400 Syringe Barrel 60cc Luer Lock

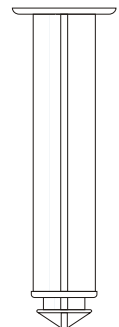

Plungers

Part No. Description

401L-4	1cc Plunger
403L-4	3cc Plunger
406L-4	6cc Plunger
410L-4	10cc Plunger
420L-4	20cc Plunger
435L-4	35cc Plunger
460L-4	60cc Plunger



Tip Caps

Part No. Description

15LL	Luer Lock Tip Cap
15LL-B	Black Luer Lock Tip Cap



End Caps

Part No. Description

TS2X	3cc End Cap
TS5	6cc End Cap
TS7	10cc End Cap
TS12	35cc End Cap
TS13	60cc End Cap

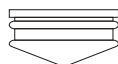

Stoppers

Rubber stoppers listed are not lubricated. For lubricated stoppers add -LUB to the part number.

Part No. Description

401L-2	1cc Rubber Stopper, Manual
403L-2	3cc Rubber Stopper, Manual
406L-2	6cc Rubber Stopper, Manual
410L-2	10cc Rubber Stopper, Manual
420L-2	20cc Rubber Stopper, Manual
435L-2	35cc Rubber Stopper, Manual
460L-2	60cc Rubber Stopper, Manual

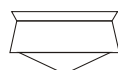

403L-7	3cc Plastic Wiper Stopper, Manual
406L-7	6cc Plastic Wiper Stopper, Manual
410L-7	10cc Plastic Wiper Stopper, Manual
435L-7	35cc Plastic Wiper Stopper, Manual

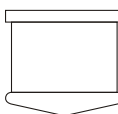

401L-2	1cc Rubber Stopper, Air Powered
403L-2	3cc Rubber Stopper, Air Powered
406L-8	6cc Rubber Stopper, Air Powered
410L-8	10cc Rubber Stopper, Air Powered
435L-8	35cc Rubber Stopper, Air Powered

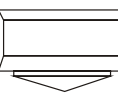

403L-9	3cc Plastic Wiper Stopper, Air Powered
406L-9	6cc Plastic Wiper Stopper, Air Powered
410L-9	10cc Plastic Wiper Stopper, Air Powered
435L-9	35cc Plastic Wiper Stopper, Air Powered
460L-9	60cc Plastic Wiper Stopper, Air Powered



Receiver Head Assemblies

The connecting link between time/pressure controllers and Syringe Assemblies, Receiver Head Assemblies provide a safe connection between receiver head and syringe barrel for accident proof dispensing. Receiver Head Assemblies come with no tubing (-R), 3 feet of tubing (-3) or 6 feet of tubing (-6).

900 Series Receiver Head Assemblies

Part No.	Size
900-250-3, -6 or -R	1cc
900-350-3, -6 or -R	3cc
900-550-3, -6 or -R	6cc
900-650-3, -6 or -R	10cc
900-950-3, -6 or -R	35cc
900-1150-3, -6 or -R	60cc



AUTHORIZED DISTRIBUTOR
[HTTP://KRAYDEN.COM](http://KRAYDEN.COM) 1-800-448-0406

400 Series Manual Syringe Components

Syringe barrels and plungers are molded from Polypropylene; stoppers are molded from Polyethylene (-7) or thermoplastic rubber (-2). Plunger locks to the stopper for smooth, controlled manual dispensing. Use of a tip cap will seal the delivery end of the syringe barrel when not dispensing.

Manual Syringes with Rubber Stoppers

Barrels and plungers are molded from Polypropylene. Stoppers are molded from thermoplastic rubber.

Size	Syringe	Stopper	Plunger
1cc	F401L-1	401L-2	401L-4
3cc	403LL-1	403L-2	403L-4
6cc	406LL-1	406L-2	406L-4
10cc	410LL-1	410L-2	410L-4
35cc	435LL-1	435L-2	435L-4
60cc	460LL-1	460L-2	460L-4

Manual Syringes with Plastic Stoppers

Barrels and plungers are molded from Polypropylene. Stoppers are molded from Polyethylene for better chemical compatibility.

Size	Syringe	Stopper	Plunger
3cc	403LL-1	403L-7	403L-4
6cc	406LL-1	406L-7	406L-4
10cc	410LL-1	410L-7	410L-4
35cc	435LL-1	435L-7	435L-4

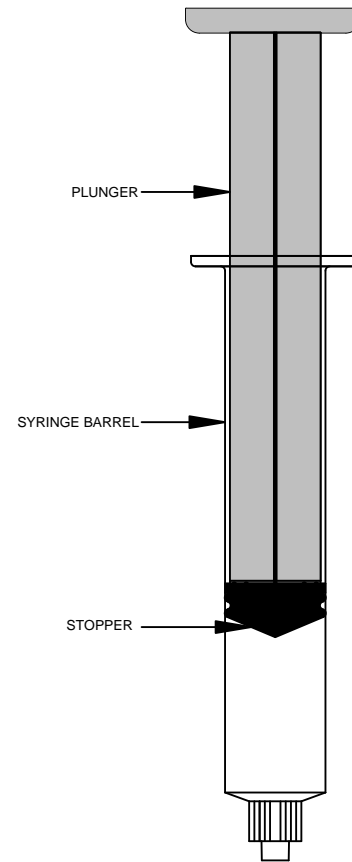

SE Series Dispensing Tips

The SE Series Dispensing Tips offer solid dispensing performance at an economical price. Made for all general dispensing applications, the SE tips have an epoxy bonded cannula as well as the same burr-free tips found in the premium TE Series.



Part Number	Hub Color	Gauge	I.D. (inches)	I.D. (mm)	Length (inches)	Length (mm)
SESE414050-1000	Olive	14	0.063	1.60	0.50	12.7
SE414100-1000	Olive	14	0.063	1.60	1.00	25.4
SE415050-1000	Amber	15	0.054	1.37	0.50	12.7
SE415100-1000	Amber	15	0.054	1.37	1.00	25.4
SE416050-1000	Grey	16	0.047	1.19	0.50	12.7
SE416100-1000	Grey	16	0.047	1.19	1.00	25.4
SE418050-1000	Green	18	0.033	0.84	0.50	12.7
SE418100-1000	Green	18	0.033	0.84	1.00	25.4
SE419050-1000	Black	19	0.028	0.71	0.50	12.7
SE419100-1000	Black	19	0.028	0.71	1.00	25.4
SE420050-1000	Pink	20	0.024	0.61	0.50	12.7
SE420100-1000	Pink	20	0.024	0.61	1.00	25.4
SE421050-1000	Purple	21	0.020	0.05	0.50	12.7
SE421100-1000	Purple	21	0.020	0.05	1.00	25.4
SE422050-1000	Blue	22	0.016	0.41	0.50	12.7
SE423050-1000	Orange	23	0.013	0.33	0.50	12.7
SE425050-1000	Red	25	0.010	0.25	0.25	6.35
SE426025-1000	Beige	26	0.010	0.25	0.25	6.35
SE427050-1000	Clear	27	0.008	0.20	0.50	12.7

TS Series Dispensing Tips

The TS Series dispensing tips offer a variety of dispensing performance and flexibility options. Stainless steel tubing is cut to precise lengths and ground to be burr-free. Cut tubing is crimped into aluminum locking insert, then molded into Polyethylene hubs. Molded hub colors correspond to gauge size. All TS Series tips secure to Techcon Systems syringe barrels and correspond to the Luer Lock specification.



Part Number	International Hub Color	Gauge	I.D. (inches)	I.D. (mm)	Length (inches)	Length (mm)
TS18-1/2-1000	Pink	18	0.033	0.838	0.5	12.7
TS18-1-1000	Pink	18	0.033	0.838	1.0	25.4
TS19-1/2-1000	Brown	19	0.028	0.711	0.5	12.7
TS19-1-1000	Brown	19	0.028	0.711	1.0	25.4
TS20-1/2-1000	Yellow	20	0.024	0.609	0.5	12.7
TS20-1-1000	Yellow	20	0.024	0.609	1.0	25.4
TS21-1/2-1000	Green	21	0.020	0.508	0.5	12.7
TS21-1-1000	Green	21	0.020	0.508	1.0	25.4
TS22-1/2-1000	Black	22	0.016	0.406	0.5	12.7
TS22-1-1000	Black	22	0.016	0.406	1.0	25.4
TS23-1/4-1000	Light Blue	23	0.013	0.330	0.25	6.35
TS23-1/2-1000	Light Blue	23	0.013	0.330	0.5	12.7
TS23-1-1000	Light Blue	23	0.013	0.330	1.0	25.4
TS25-1/2-1000	Blue	25	0.010	0.254	0.5	12.7
TS26-1/4-1000	Beige	26	0.010	0.254	0.25	6.35
TS26-1/2-1000	Beige	26	0.010	0.254	0.5	12.7
TS26-1-1000	Beige	26	0.010	0.254	1.0	25.4
TS27-1/4-1000	Grey	27	0.008	0.203	0.25	6.35
TS27-5/16-1000	Grey	27	0.008	0.203	5/16	7.94
TS30-1/4-1000	Lavender	30	0.006	0.152	0.25	6.35
TS30-5/16-1000	Lavender	30	0.006	0.152	5/16	7.94
TS30-1/2-1000	Lavender	30	0.006	0.152	0.5	12.7

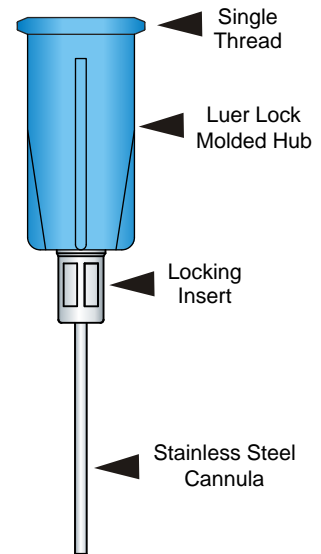

TS-M Metal Dispensing Tips

This series consists of a stainless steel cannula and aluminum hub. Sold in bulk quantity of 500.

Part Number	Domestic Hub Color	Gauge	Length Inches	Length mm
TS14-1/2M-500	Aluminum	14	0.5	12.7
TS14-1M-500	Aluminum	14	1.0	25.4
TS14-2M-500	Aluminum	14	2.0	50.8
TS15-1/2M-500	Aluminum	15	0.5	12.7
TS15-1M-500	Aluminum	15	1.0	25.4
TS15-1-1/2M-500	Aluminum	15	1.5	38.1
TS16-1M-500	Aluminum	16	1.0	25.4



AUTHORIZED DISTRIBUTOR
[HTTP://KRAYDEN.COM](http://KRAYDEN.COM) 1-800-448-0406

NEED HELP?

- QUICK QUOTE
- ORDER UPDATE
- ASK AN EXPERT
- REQUEST DOCUMENTS
- BUY NOW

1-800-448-0406